

ACCESORIOS

CHEVROLET SUBURBAN 2024



HAZ CLIC EN CADA BOTÓN Y CONÓCELOS.

EXTERIOR

INTERIOR

ELECTRÓNICOS

PERFORMANCE

**PRODUCTOS PARA
CAJUELA**

**PRODUCTOS PARA
CARGA EXTERIOR**

RINES

**SISTEMA DE
REMOLQUE**

**SEGURIDAD Y
PROTECCIÓN**



**FAMILIA
SUV**
SIGUE CRECIENDO



Portaplacas

NP 93754298

 **0.1** HR
INSTALACIÓN

 LOCAL
ENVÍO

TODAS LAS VERSIONES



Barras de techo negras

NP 87855062

 **0.2** HR
INSTALACIÓN

 LOCAL
ENVÍO

TODAS LAS VERSIONES



Calcomanía para cofre

NP 85581001

 **0.3** HR
INSTALACIÓN

 LOCAL
ENVÍO

TODAS LAS VERSIONES



Cubierta de espejo
en cromo

NP 84703354

 **0.8** HR
INSTALACIÓN

 **LOCAL**
ENVÍO

TODAS LAS VERSIONES



Cubierta de espejo
en negro

NP 84703355

 **0.8** HR
INSTALACIÓN

 **LOCAL**
ENVÍO

TODAS LAS VERSIONES



Emblema Chevrolet
en negro

NP 84832382

 **0.3** HR
INSTALACIÓN

 **LOCAL**
ENVÍO

TODAS LAS VERSIONES



Emblema Suburban
en negro

NP 85593460

 **0.7** HR
INSTALACIÓN

 LOCAL
ENVÍO

TODAS LAS VERSIONES



Emblemas “High
Country”, “Duramax”,
“Premier” en negro

NP 84719528

 **1.1** HR
INSTALACIÓN

 LOCAL
ENVÍO

HIGH COUNTRY



Loderas delanteras
moldeadas en negro

NP 84433550

 **0.5** HR
INSTALACIÓN

 LOCAL
ENVÍO

LT & RST



Loderas traseras
moldeadas en negro

NP 84938120

 **0.5** HR
INSTALACIÓN

 **LOCAL**
ENVÍO

LT & RST



Parrilla negra con letras
Chevrolet

NP 86820490

 **1.4** HR
INSTALACIÓN

 **LOCAL**
ENVÍO

LT Y RST



Kit de mascotas

NP 93754051



1 HR

INSTALACIÓN



LOCAL

ENVÍO

TODAS LAS VERSIONES



Cinturón de fijación
y pechera

NP 93754053



0.2 HR

INSTALACIÓN



LOCAL

ENVÍO

TODAS LAS VERSIONES



Cubierta de asientos
traseros

NP 93754052



0.2 HR

INSTALACIÓN



LOCAL

ENVÍO

TODAS LAS VERSIONES



Protector interior
de puertas

NP 93754055

 **0.3** HR
INSTALACIÓN

 **LOCAL**
ENVÍO

TODAS LAS VERSIONES



Barrera para asiento
delantero de malla

NP 93754054

 **0.3** HR
INSTALACIÓN

 **LOCAL**
ENVÍO

TODAS LAS VERSIONES



Compartimento de
seguridad para consola

NP 84404148

 **0.1** HR
INSTALACIÓN

 **LOCAL**
ENVÍO

TODAS LAS VERSIONES



Cubierta de pedal
deportiva

NP 84712883

 **0.4** HR
INSTALACIÓN

 **LOCAL**
ENVÍO

TODAS LAS VERSIONES



Tapete de vinil 1.^a fila
en café oscuro

NP 84701520

 **0.1** HR
INSTALACIÓN

 **LOCAL**
ENVÍO

TODAS LAS VERSIONES



Tapete de vinil 1ra fila
en negro

NP 84503126

 **0.1** HR
INSTALACIÓN

 **LOCAL**
ENVÍO

TODAS LAS VERSIONES



Tapete de vinil 2da fila
en café oscuro

NP 84701535

 **0.1** HR
INSTALACIÓN

 **LOCAL**
ENVÍO

TODAS LAS VERSIONES



Tapete de vinil 2da fila
en negro

NP 84503157

 **0.1** HR
INSTALACIÓN

 **LOCAL**
ENVÍO

TODAS LAS VERSIONES



Tapete de vinil rígido 1ra fila en café oscuro

NP 84646686

 **0.1 HR**
INSTALACIÓN

 **LOCAL**
ENVÍO

TODAS LAS VERSIONES



Tapete de vinil rígido 1ra fila en negro

NP 84646685

 **0.1 HR**
INSTALACIÓN

 **LOCAL**
ENVÍO

TODAS LAS VERSIONES



Tapete de vinil rígido 1ra fila en negro con emblema Chevrolet plateado

NP 84776598

 **0.1 HR**
INSTALACIÓN

 **LOCAL**
ENVÍO

TODAS LAS VERSIONES

Tapete de vinil rígido
2da fila en café oscuro



NP 84646721

 **0.1** HR
INSTALACIÓN

 **LOCAL**
ENVÍO

TODAS LAS VERSIONES

Tapete de vinil rígido
2da fila en negro



NP 84646720

 **0.1** HR
INSTALACIÓN

 **LOCAL**
ENVÍO

TODAS LAS VERSIONES



Tapete de vinil rígido
3ra fila en café oscuro
(modelos con asientos
de banca)

NP 84646758

 **0.1** HR
INSTALACIÓN

 **LOCAL**
ENVÍO

LT & RST



Tapete de vinil rígido
3ra fila en negro
(modelos con asientos
de banca)

NP 84646757

 **0.1** HR
INSTALACIÓN

 **LOCAL**
ENVÍO

LT & RST



Tapete de vinil rígido
3ra fila en negro
(modelos con asientos
de capitán)

NP 84646745

 **0.1** HR
INSTALACIÓN

 **LOCAL**
ENVÍO

HIGH COUNTRY

ELECTRÓNICOS



MENÚ



Emblema Chevrolet
iluminado en negro

NP 85143904



1 HR

INSTALACIÓN



LOCAL

ENVÍO

TODAS LAS VERSIONES



Protector de solera
iluminado delantero y
trasero Suburban

NP 84507712



1.5 HR

INSTALACIÓN



LOCAL

ENVÍO

TODAS LAS VERSIONES



Proyector de logo para
espejos

NP 84408372



0.1 HR

INSTALACIÓN



LOCAL

ENVÍO

LT & RST

PERFORMANCE



MENU



Punta de escape de 3.6L o 5.3L en negro cromado con logotipo Chevrolet

NP 84513870



0.1 HR

INSTALACIÓN



LOCAL

ENVÍO

LT & RST



Punta de escape sencilla de 5.3L de fibra de carbón

NP 84513857



0.1 HR

INSTALACIÓN



LOCAL

ENVÍO

LT & RST



Punta de escape sencilla de 5.3L en acabado pulido con logo Chevrolet

NP 84439200

 **0.1** HR
INSTALACIÓN

 **LOCAL**
ENVÍO

LT & RST



Sistema de escape de 5.3L salida única con punta cromada

NP 84460753

 **0.7** HR
INSTALACIÓN

 **LOCAL**
ENVÍO

LT & RST

Sistema de escape de
6.2L doble salida

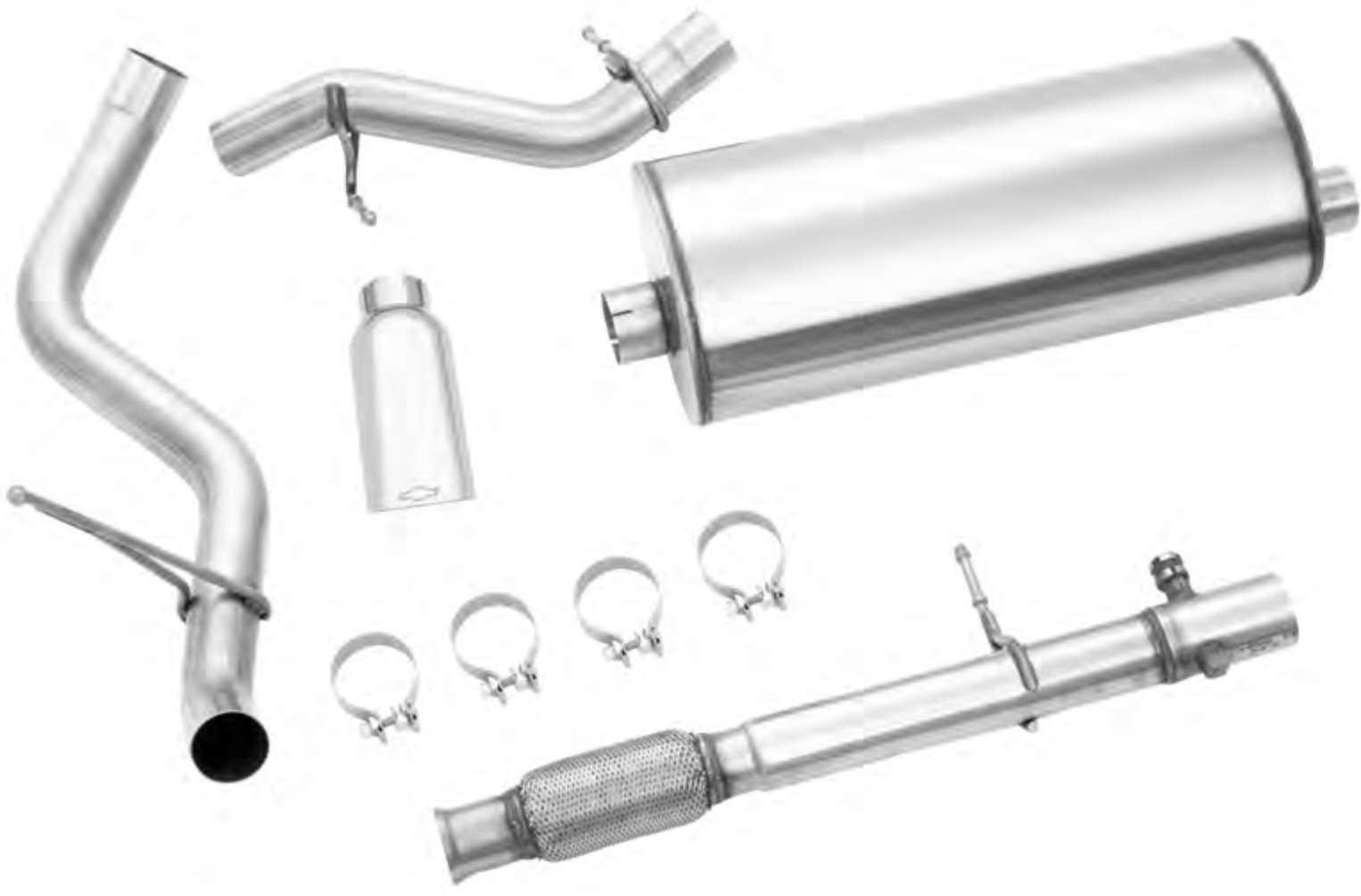

NP 84888292

 **1.6 HR**
INSTALACIÓN

 **LOCAL**
ENVÍO

HIGH COUNTRY



Sistema de frenado
frontal Brembo en rojo

NP 85138043

 **2 HR**
INSTALACIÓN

 **LOCAL**
ENVÍO

TODAS LAS VERSIONES



Sistema de frenado
trasero de alto
rendimiento en rojo

NP 84436255

 **1.2 HR**
INSTALACIÓN

 **LOCAL**
ENVÍO

TODAS LAS VERSIONES

PRODUCTOS PARA CAJUELA



MENU



Organizador de cajuela

NP 93754193



0.1 HR

INSTALACIÓN



LOCAL

ENVÍO

TODAS LAS VERSIONES



Red de carga vertical
con logo Chevrolet

NP 84444362



0.1 HR

INSTALACIÓN



LOCAL

ENVÍO

TODAS LAS VERSIONES



Red de carga vertical

NP 84050683



0.1 HR

INSTALACIÓN



LOCAL

ENVÍO

TODAS LAS VERSIONES



Organizador de cajuela
en negro con logo
Chevrolet

NP 85543592



0 HR

INSTALACIÓN



LOCAL

ENVÍO

TODAS LAS VERSIONES



Sombra de seguridad
para area de carga en
café oscuro

NP 84390977



0.1 HR

INSTALACIÓN



LOCAL

ENVÍO

TODAS LAS VERSIONES



Sombra de seguridad
para area de carga en
negro

NP 84390976



0.1 HR

INSTALACIÓN



LOCAL

ENVÍO

TODAS LAS VERSIONES



Tapete de alfombra
en negro con
organizadores
integrados

NP 84958043

 **0.1** HR
INSTALACIÓN

 **LOCAL**
ENVÍO

TODAS LAS VERSIONES



Tapete de vinil rígido
cubierta extendida en
café oscuro

NP 85539122

 **0.1** HR
INSTALACIÓN

 **LOCAL**
ENVÍO

TODAS LAS VERSIONES



Tapete de vinil rígido
cubierta extendida
en negro con logotipo
Chevrolet

NP 85539121

 **0.1** HR
INSTALACIÓN

 **LOCAL**
ENVÍO

TODAS LAS VERSIONES

PRODUCTOS PARA CARGA EXTERIOR



MENÚ



Canastilla 129x99cm

NP 93754306

 **0.4** HR
INSTALACIÓN

 LOCAL
ENVÍO

TODAS LAS VERSIONES



Canastilla 159x99cm

NP 93754307

 **0.4** HR
INSTALACIÓN

 LOCAL
ENVÍO

TODAS LAS VERSIONES



Concha portaequipaje
320L

NP 93754303

 **0.2** HR
INSTALACIÓN

 LOCAL
ENVÍO

TODAS LAS VERSIONES



Concha portaequipaje
450L

NP 93754304

 **0.2** HR
INSTALACIÓN

 **LOCAL**
ENVÍO

TODAS LAS VERSIONES



Concha portaequipaje
520L

NP 93754305

 **0.2** HR
INSTALACIÓN

 **LOCAL**
ENVÍO

TODAS LAS VERSIONES



Portabicicletas

NP 93754324

 **0.4** HR
INSTALACIÓN

 **LOCAL**
ENVÍO

TODAS LAS VERSIONES



Red de carga 1.25m

NP 93754325

 **0** HR
INSTALACIÓN

 **LOCAL**
ENVÍO

TODAS LAS VERSIONES



Red de carga 1.40m

NP 93754326

 **0** HR
INSTALACIÓN

 **LOCAL**
ENVÍO

TODAS LAS VERSIONES



Portabicicletas de tirón

NP 93754264

 **0.4** HR
INSTALACIÓN

 **LOCAL**
ENVÍO

TODAS LAS VERSIONES



Tapones para válvula de llanta

NP 93754299

 **0.1** HR
INSTALACIÓN

 LOCAL
ENVÍO

TODAS LAS VERSIONES



Birlos cromados

NP 85105298

 **0.4** HR
INSTALACIÓN

 LOCAL
ENVÍO

TODAS LAS VERSIONES



Birlos negros
(24 piezas)

NP 85105297

 **0.2** HR
INSTALACIÓN

 LOCAL
ENVÍO

TODAS LAS VERSIONES



Centro de rin
en aluminio con logo
dorado

NP 19301595

 **0.1** HR
INSTALACIÓN

 **LOCAL**
ENVÍO

TODAS LAS VERSIONES



Centro de rin negro
con logo Chevrolet
en dorado

NP 84375184

 **0.1** HR
INSTALACIÓN

 **LOCAL**
ENVÍO

TODAS LAS VERSIONES



Centro de rin negro
con logo Chevrolet
en negro

NP 84388541

 **0.1** HR
INSTALACIÓN

 **LOCAL**
ENVÍO

TODAS LAS VERSIONES



Centro de rin plateado
brillante con logo
Chevrolet en dorado

NP 19301597

 **0.1** HR
INSTALACIÓN

 **LOCAL**
ENVÍO

TODAS LAS VERSIONES



Centro de rin plateado
con logo Chevrolet
plateado

NP 19301593

 **0.4** HR
INSTALACIÓN

 **LOCAL**
ENVÍO

TODAS LAS VERSIONES



Monitor de presión
de llantas

NP 84991144

 **0.1** HR
INSTALACIÓN

 **LOCAL**
ENVÍO

TODAS LAS VERSIONES



Rin de 22" en negro con insertos en aluminio de 5 brazos

NP 84582669

 **0.4 HR**
INSTALACIÓN

 **LOCAL**
ENVÍO

RST & HC



Rin de aluminio 22" cromado con 6 brazos (diseño 1)

NP 84453001

 **0.4 HR**
INSTALACIÓN

 **LOCAL**
ENVÍO

RST & HC



Rin de aluminio 22" en negro brillante de 5 brazos

NP 84799395

 **0.4 HR**
INSTALACIÓN

 **LOCAL**
ENVÍO

RST & HC



Rin de aluminio 22''
en negro con detalles
en plata de 6 brazos

NP 84799390

 **0.4** HR
INSTALACIÓN

 LOCAL
ENVÍO

RST & HC



Rin de aluminio 22''
en negro de 6 brazos

NP 84802386

 **0.4** HR
INSTALACIÓN

 LOCAL
ENVÍO

RST & HC



Rin de aluminio de 20''
en negro de 6 brazos

NP 84582671

 **0.4** HR
INSTALACIÓN

 LOCAL
ENVÍO

LT



Rin de aluminio de 22”
cromado de 6 brazos
(diseño 1)

NP 84802385

 **0.4** HR
INSTALACIÓN

 **LOCAL**
ENVÍO

RST & HC



Rin de aluminio de 22”
cromado de 6 brazos

NP 84802384

 **0.4** HR
INSTALACIÓN

 **LOCAL**
ENVÍO

RST & HC



Rin de aluminio de 22”
cromado de 6 brazos
(diseño 3)

NP 84799388

 **0.4** HR
INSTALACIÓN

 **LOCAL**
ENVÍO

RST & HC

SISTEMA DE REMOLQUE



MENU



Arnés de remolque

NP 12497781



0 HR

INSTALACIÓN



LOCAL

ENVÍO

TODAS LAS VERSIONES

SEGURIDAD Y PROTECCIÓN



MENÚ



Birlos de seguridad

NP 93753767

 **0.4** HR
INSTALACIÓN

 LOCAL
ENVÍO

TODAS LAS VERSIONES



Película de seguridad
transparente

NP 19161096

 **2.5** HR
INSTALACIÓN

 LOCAL
ENVÍO

TODAS LAS VERSIONES



Película de seguridad
y control solar CS15

NP 19186110

 **2.5** HR
INSTALACIÓN

 LOCAL
ENVÍO

TODAS LAS VERSIONES



Película de seguridad
y control solar CS35

NP 19161094

 **2.5** HR
INSTALACIÓN

 **LOCAL**
ENVÍO

TODAS LAS VERSIONES



Película de seguridad
y control solar CS50

NP 19161095

 **2.5** HR
INSTALACIÓN

 **LOCAL**
ENVÍO

TODAS LAS VERSIONES



Cinta de protección
de pintura para filos
de puerta (30 metros)

NP 93754006

 **2.5** HR
INSTALACIÓN

 **LOCAL**
ENVÍO

TODAS LAS VERSIONES



Rollo de protección
de pintura (30 metros)

NP 93754007

 **2.5** HR
INSTALACIÓN

 **LOCAL**
ENVÍO

TODAS LAS VERSIONES



Extintor (4 piezas)

NP 93754096

 **0** HR
INSTALACIÓN

 **SHIP DIRECT**
ENVÍO

TODAS LAS VERSIONES



Kit de emergencia
básico

NP 93754094

 **0** HR
INSTALACIÓN

 **SHIP DIRECT**
ENVÍO

TODAS LAS VERSIONES



Kit de emergencia premium

NP 93754095

 **2.5** HR
INSTALACIÓN

 **SHIP DIRECT**
ENVÍO

TODAS LAS VERSIONES



Base de silla de bebé

NP 52160581

 **0** HR
INSTALACIÓN

 **LOCAL**
ENVÍO

TODAS LAS VERSIONES



Silla de bebé

NP 52157160

 **0** HR
INSTALACIÓN

 **LOCAL**
ENVÍO

TODAS LAS VERSIONES

Birlos de seguridad cromados



NP 85548789

 **0.1** HR
INSTALACIÓN

 **LOCAL**
ENVÍO

TODAS LAS VERSIONES

Kit birlos y birlos de seguridad en negro



NP 85105299

 **0.4** HR
INSTALACIÓN

 **LOCAL**
ENVÍO

TODAS LAS VERSIONES

Triángulo reflector



NP 22745654

 **0** HR
INSTALACIÓN

 **LOCAL**
ENVÍO

TODAS LAS VERSIONES

ACCESORIOS CHEVROLET SUBURBAN 2024



MENÚ



3 AÑOS
DE GARANTÍA



ASISTENCIA EN
EL CAMINO CHEVROLET



En General Motors de México, S. de R.L. de C.V. (en lo sucesivo "GMM") mantenemos las técnicas de fabricación de los vehículos en continuo desarrollo, por lo que nos reservamos el derecho de hacer cambios a la información contenida en este catálogo en cuanto a los modelos, rendimiento, colores, especificaciones, equipamiento, apariencia y/o accesorios, en cualquier momento y sin previo aviso. Por lo anterior, le recomendamos que, antes de la compra y entrega del vehículo Chevrolet®, verifique toda la información con su Distribuidor Autorizado Chevrolet o bien que consulte nuestra página de internet chevrolet.com.mx. Para más información acerca del sistema de info-entretenimiento Apple CarPlay™ y Android Auto™, o bien respecto a los servicios de Asistencia en el Camino Chevrolet, le pedimos consulte con su Distribuidor Autorizado Chevrolet o bien en la página de internet señalada anteriormente. La información sobre rendimiento de combustible combinado se refiere al valor que se obtuvo en condiciones controladas de laboratorio, de acuerdo con la metodología de la NOM-163-SEMARNAT-ENER-SCFI-2013, que pueden no ser reproducibles ni obtenerse en condiciones y hábitos de manejo convencional, debido a condiciones climatológicas, combustible, condiciones topográficas y otros factores. Garantía de defensa a defensa para Chevrolet Suburban® 2024: 60,000 km ó 3 años, lo que ocurra primero. Consulte términos, condiciones y restricciones en la Póliza de Garantía entregada en cada vehículo nuevo. Para mayores informes acerca de cualquier vehículo Chevrolet® o servicio GMM, llame al Centro de Atención a Clientes Chevrolet en su teléfono 800-466-0811, o envíe un e-mail a asistencia.chevrolet@gm.com. Las funciones y alertas de seguridad no sustituyen la responsabilidad del conductor para operar el vehículo de forma segura y conforme a las regulaciones de tránsito aplicables en su localidad. El conductor debe mantenerse atento al tráfico, entorno y condiciones del camino en todo momento. Lea el Manual del Propietario del vehículo para obtener más información importante en materia de seguridad. El servicio de OnStar® funciona únicamente si su vehículo está en un lugar en el que OnStar® tenga convenio con un proveedor de servicio inalámbrico para poder dar el servicio en dicha zona; asimismo, requiere del sistema eléctrico del vehículo, del servicio inalámbrico y tecnologías satelitales GPS para estar disponible. OnStar® de México no ofrece garantía de que el servicio será ininterrumpido, oportuno, seguro o libre de error. Otros problemas fuera del alcance de OnStar® pueden limitar los servicios que se proporcionan. Para conocer la disponibilidad de vehículos, detalles y limitaciones del sistema, visite onstar.com.mx. Los servicios y la conectividad 4G LTE WI-FI® pueden variar dependiendo del modelo y las condiciones, algunos servicios pueden requerir un plan de datos adicional. La marca OnStar® y su respectivo logotipo son propiedad de OnStar® LLC y OnStar® de México, S. de R.L. de C.V. (OnStar®) es licenciataria autorizada de dicha marca para su uso y explotación en los Estados Unidos Mexicanos. "D. R. ©; ONSTAR DE MÉXICO, S. DE R.L. DE C.V., Av. Ejército Nacional No.843-B, Col. Granada, C.P. 11520, Ciudad de México, México, 2020". Algunas imágenes del catálogo son de carácter ilustrativo. Las marcas Chevrolet®, Chevrolet Suburban®, así como sus respectivos logos y avisos comerciales, son propiedad de General Motors LLC y GMM es su licenciataria autorizada en los Estados Unidos Mexicanos. "D.R. ©; GENERAL MOTORS DE MÉXICO, S. DE R.L. DE C.V., Av. Ejército Nacional No.843-B, Col. Granada, C.P. 11520, Ciudad de México, México, 2023".